

1
2 THRU 12

3
4 AND 5

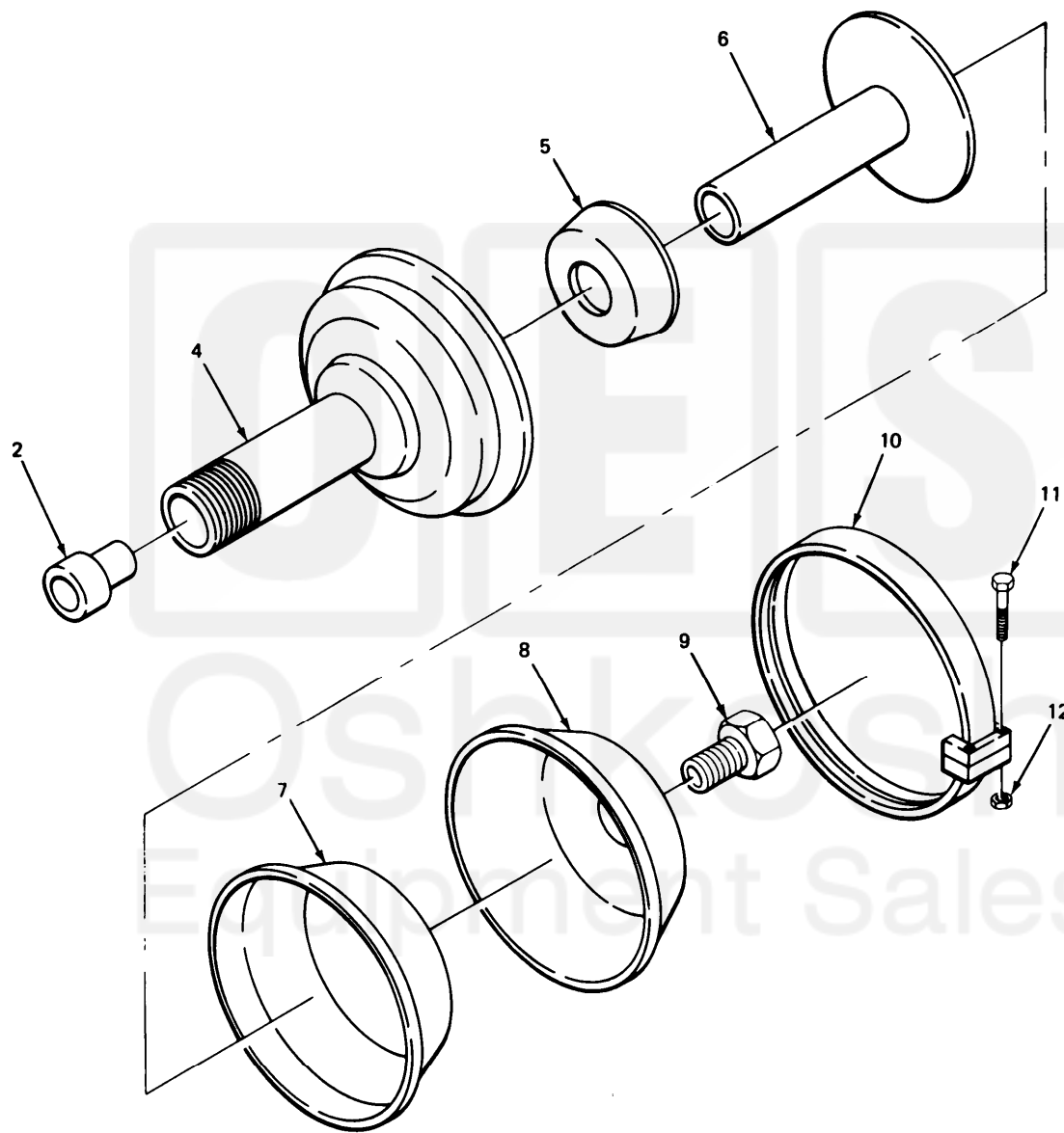

TA212308

FIGURE 173. FRONT AXLE AIR BRAKE CHAMBER.

Current part is item (2) on diagram. Available at www.oshkoshequipment.com

SECTION II				TM9-2320-270-34P	
(1)	(2)	(3)	(4)	(5)	(6)
ITEM NO.	SMR CODE	FSCM	PART NUMBER	DESCRIPTION AND USABLE ON CODE (UOC)	QTY
GROUP 1208 AIR BRAKE SYSTEM					
FIG. 173 FRONT AXLE AIR BRAKE CHAMBER					
1	PAOOO	7850C	A10-3775P16	CHAMBER,AIR BRAKE FRONT AXLE	2
2	PAOZZ	63734	1779Q433	GUIDE,BRAKE ASSEMBL	1
3	XAOOO	78500	A8-3780P84	HOUSING ASSEMBLY, N ON-PRESSURE	1
4	XAOZZ	78500	3780F84	HOUSING, CHAMBER	1
5	PAOZZ	78500	2760U21	BOOT,DUST AND MOIST	1
6	XAOZZ	78500	A38-1779X232	ROD, PUSH	1
7	PAOZZ	78500	27978106	DIAPHRAGM	1
8	XAOZZ	78500	A3780N66	PLATE PRESSURE	1
9	PAOZZ	21450	444618	PLUG,PIPE	1
10	PAOZZ	78500	2797M117	CLAMP,RING	1
11	PAOZZ	78500	1779-A-235	BOLT,SPECIAL HEAD	2
12	PAOZZ	78500	1727J10	NUT,PLAIN,HEXAGON	2
END OF FIGURE					



Current part is item (2) on diagram. Available at www.oshkoshequipment.com